

# **Motic<sup>®</sup>**

## **BA410E Series Biological Microscope Instruction Manual**

---



Note

If the equipment is used in a manner not specified by the manufacturer, the protection provided by the equipment may be impaired.

[WWW.MOTIC.COM](http://WWW.MOTIC.COM)

---

MOTIC INCORPORATION LTD.

We are constantly endeavouring to improve our instruments and to adapt them to the requirements of modern research techniques and testing methods. This involves modification to the mechanical structure and optical design of our instruments.

Therefore, all descriptions and illustrations in this instruction manual, including all specifications are subject to change without notice.

## **Infinity corrected optics**

In this optical concept the light beams are parallel after leaving the objective in the direction of the eyepieces. A second optical element, the tube lens (normally located in the eyepiece tube) is used to converge the parallel beams, resulting in an intermediate image. The intermediate image is focussed by the eyepieces, to provide the real image for visual observation.

The implementation of a tube lens gives the opportunity to minimize chromatic aberrations and other “optical defects”. Further, in “Infinity Optics” the distance between the objective and tube lens is not as strictly fixed as in the (historically older) “Finite Optics” of 160mm tube length.

This allows additional optical components to be inserted between the objective and tube head.

Fluorescence attachments, discussion bridges, eye level risers and other options can be added without affecting the image quality.

In general “Infinity Optics” provides flexibility and the opportunity to add additional optional features.

## Microscope terminology

### Abbe Condenser

A two-lens sub-stage condenser located below the stage of a microscope and functions to collect light and direct it onto the object being examined. Its high numerical aperture makes it particularly suited for use with most medium- and high-magnification objectives.

### Aperture, Numerical (N.A.)

The numerical aperture is an important factor determining the efficiency of the condenser and objective. It is represented by the formula:  $(N.A. = n \sin \alpha)$ , where  $n$  is the refractive index of a medium (air, water, immersion oil etc.) between the objective and the specimen or condenser, and  $\alpha$  is half of the maximum angle at which light enters or leaves the lens from or to a focused object point on the optical axis.

### Cover Glass Thickness

Transmitted light objectives are designed to image specimens that are covered by a thin cover glass (**cover slip**). The thickness of this small glass piece is now standardized at 0.17 mm for most applications.

### Diaphragm, Condenser

A diaphragm, which controls the effective size of the condenser aperture. A synonym for the condenser illuminating aperture diaphragm.

### Magnification

The number of times by which the size of the image exceeds the original object. Lateral magnification is usually meant. It is the ratio of the distance between two points in the image to the distance between the two corresponding points in the object.

### Micrometer: *um*

A metric unit of length measurement  
=  $1 \times 10^{-6}$  meters or 0.000001 meters

### Nanometer (nm)

A unit of length in the metric system equal to  $10^{-9}$  meters.

### Phase-contrast (microscopy)

A form of microscopy, which converts differences in object thickness and refractive index into differences in image amplitude and intensity.

### Real Viewfield

The diameter in millimetres of the object field.

$$\text{Real Viewfield} = \frac{\text{Eyepiece Field of View}}{\text{Objective Magnification}}$$

**Diopter adjustment**

The adjustment of the eyepiece of an instrument to provide accommodation for the eyesight differences of individual observers.

**Depth of Focus**

The axial depth of the space on both sides of the image plane within which the image is sharp. The larger the N.A. of objective, the shallower the depth of focus.

**Field of View (F.O.V.)**

That part of the image field, which is imaged on the observer's retina, and hence can be viewed at any one time. The field of view number is now one of the standard markings of the eyepiece.

**Filter**

Filters are optical elements that selectively transmit light. It may absorb part of the spectrum, or reduce overall intensity or transmit only specific wavelengths.

**Immersion Oil**

Any liquid occupying the space between the object and microscope objective. Such a liquid is usually required by objectives of 3-mm focal length or less.

**Resolving Power**

A measure of an optical system's ability to produce an image which separates two points or parallel lines on the object.

**Resolution**

The result of displaying fine details in an image

**Total Magnification**

The total magnification of a microscope is the individual magnifying power of the objective multiplied by that of the eyepiece.

**Working Distance**

This is the distance between the objective front lens and the top of the cover glass when the specimen is in focus. In most instances, the working distance of an objective decreases as magnification increases.

**X-axis**

The axis that is usually horizontal in a two-dimensional coordinate system. In microscopy X-axis of the specimen stages is considered that which runs left to right.

**Y-axis**

The axis that is usually vertical in a two-dimensional coordinate system. In microscopy Y-axis of the specimen stages is considered that which runs front to back.

## Table of contents

Section	Page
<b>1. Nomenclature</b>	<b>7</b>
1.1 Application	7
1.2 Nomenclature	8
<b>2. Setting up the instrument</b>	<b>10</b>
2.1 Operating environment	10
<b>3. Assembling the microscope</b>	<b>11</b>
3.1 Verifying Input voltage	11
3.2 Illumination	11
3.3 Rackless stage	12
3.4 Specimen holder	12
3.5 Objectives	12
3.6 Condenser	13
3.7 Eyepiece tube	13
3.8 Eyepieces	14
3.9 Filters	14
3.10 Power cord	15
<b>4. Usage of microscope components</b>	<b>16</b>
4.1 Coarse and fine focusing	16
4.2 Coarse focus torque adjustment	16
4.3 Coarse Focus Quick Stop	17
4.4 Stage Upper Limit Stop adjustment	17
4.5 Using Thicker Samples	18
4.6 Beam Splitter Lever	18
4.7 Interpupillary distance adjustment	19
4.8 Diopter adjustment	19
4.9 Centering the condenser	20
4.10 Use of aperture diaphragm	21
4.11 Use of field diaphragm	21
4.12 Brightness and contrast adjustment	22

4.13. IR function	22
4.14 Auto light intensity reproduction	22
4.15 Filters cassette	23
<b>5. Photomicrographic procedure</b>	<b>24</b>
<b>6. Using oil immersion objective</b>	<b>25</b>
<b>7. Troubleshooting table</b>	<b>26</b>
<b>8. Care and maintenance</b>	<b>28</b>
8.1. Do not disassemble	28
8.2 Cleaning the Microscope	28
8.3 Disinfecting the Microscope	28
8.4 When not in use	28
8.5 Bulb Replacement	29
<b>9. Warning labels</b>	<b>32</b>

# 1. Nomenclature

## 1.1 Application

Designed for multiple disciplines from University through clinical, laboratory, and research applications, the BA410E offers true professional quality with a full complement of accessories, making it a valued addition for any biological application.

## 1.2 Nomenclature

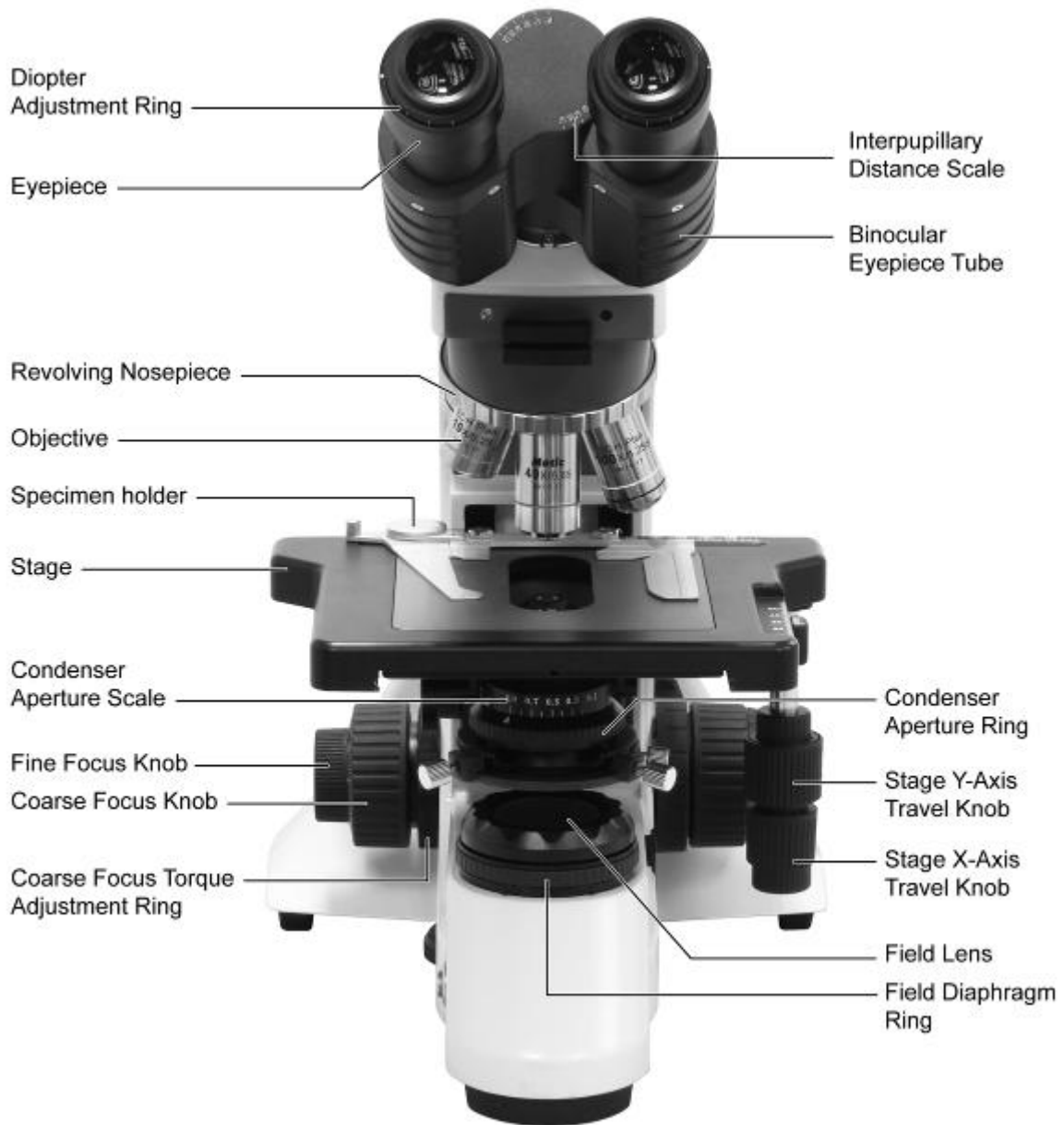

BA410E-50W Halogen (Binocular)



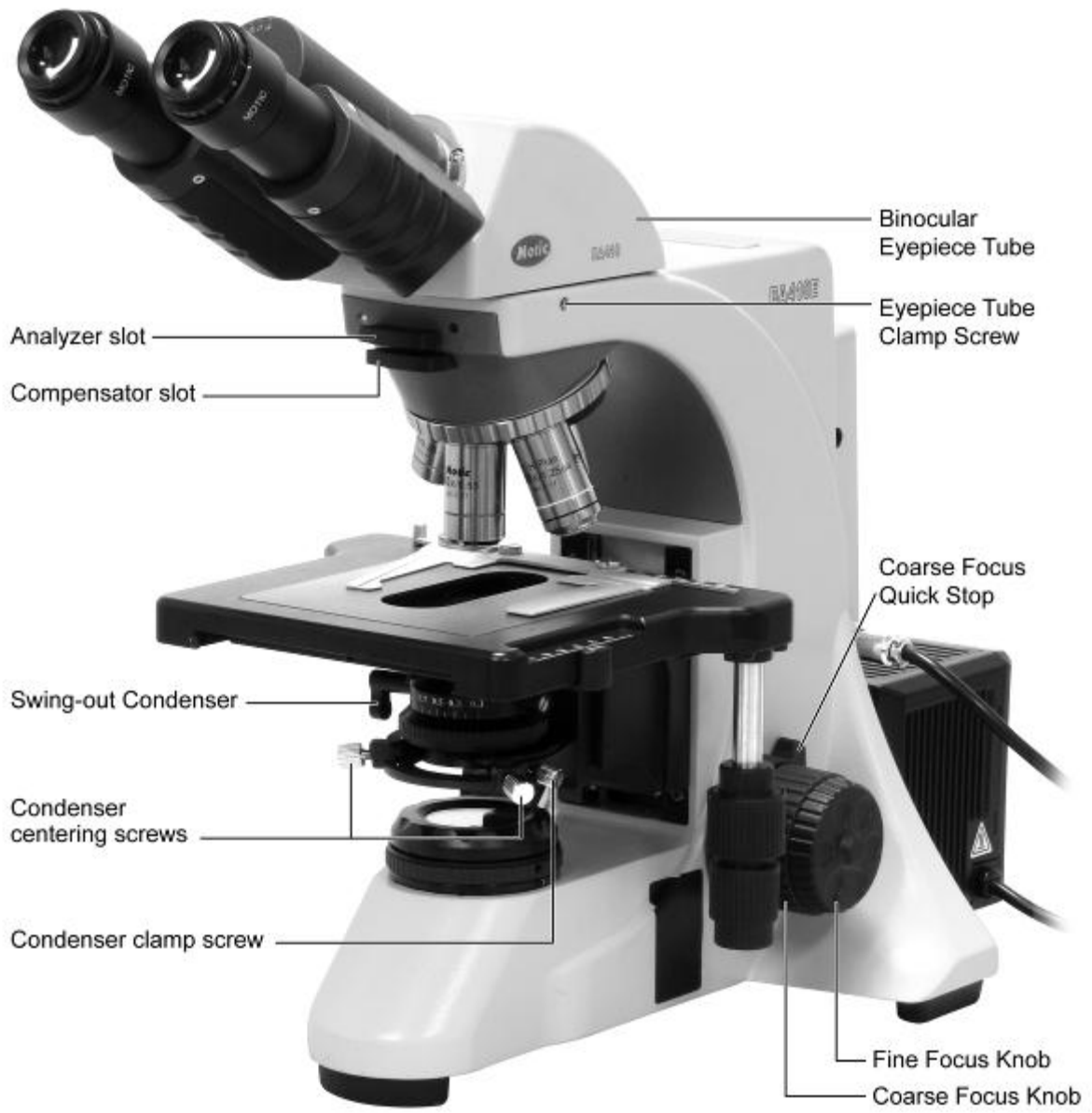

BA410E-50W Halogen (Binocular)



BA410E-50W Halogen (Binocular)

## 2. Setting up the instrument

Avoid placing the instrument in locations exposed to direct sunlight, dust, vibration, high temperature, high humidity and where it is difficult to unplug the power supply cord.

### 2.1 Operating environment

- Indoor use
- Altitude: Max 2000 meters
- Ambient temperature: 5°C to 40°C
- Maximum relative humidity: 80% for temperature up to 31°C decreasing linearly to 50% relative humidity at 40°C
- Supply voltage fluctuations: Not to exceed  $\pm 10\%$  of the normal voltage
- Pollution degree: 2 (in accordance with IEC60664)
- Installation/ Overvoltage category: 2 (in accordance with IEC60664)
- Air Pressure of 75kPa to 106kPa
- Avoid frost, dew, percolating water, and rain
- Install electrical devices at least 10 cm from the wall and away from flammable substances.

## 3. Assembling the microscope

### 3.1 Verifying Input voltage

- The automatic voltage selection works with a broad range of settings. However, always use a power cord that is rated for the voltage used in your area and that has been approved to meet local safety standards. Using the wrong power cord could cause fire or equipment damage.
- If using an extension cord, use only a power supply cord with a protective earth (PE) wire.
- In order to prevent electric shock, always turn the power supply off before connecting the power cord.

- Electrical Specifications:

#### **50W Halogen bulb**

Input: 100-240V~, 70W, 50-60Hz

Bulb: 12VDC 50W Halogen

Fuse: 250V T2.5A (If the original fuse is blown, please replace with specified fuse)

#### **100W Halogen bulb**

Input: 100-240V~, 120W, 50-60Hz

Bulb: 12VDC 100W Halogen

Fuse: 250V T2.5A (If the original fuse is blown, please replace with specified fuse)

#### **LED module**

Input: 100-240V~, 80VA, 50-60Hz

LED: 3.4V --- 3W

Fuse: 250V T2.5A (If the original fuse is blown, please replace with specified fuse)

- LED module high color temperature: 6000 ± 300k
- LED module low color temperature: 4500 ± 300k

### 3.2 Illumination

#### 3.2.1 Halogen lamp

- The quartz halogen bulb, used as a light source, has higher luminance and color temperature than conventional tungsten bulb. The luminance is approximately four times greater.
- As long as the bulb voltage is kept constant, the halogen bulb maintains the same level of brightness and color temperature regardless of whether it is new or nearing the end of its life.

### 3.2.2 Lamp house

- Loosen the round dovetail clamp screw on the microscope stand, insert the lamp house into the round dovetail on the microscope stand.
- Tighten the clamp screw to secure the lamp house in place. The microscope can only use the lamp house provided by Motic.

### 3.2.3 LED module

- The LED module is specially designed to be inserted into halogen bulb socket directly converting halogen illumination to LED illumination. LED is more economical and environmental friendly and combines the advantages of low heat and long life span.

## 3.3 Rackless stage

- Loosen the stage clamp screw; fit the stage into the circular dovetail mount. An orientation notch at the back of the stage has to fit to an orientation pin at the stage carrier. Tighten with the clamp screw facing forward.

- Torque adjustment:

The torque of the y-axis and x-axis travel knobs can be adjusted by torque adjusting knobs.

For y-axis to (+) increase or (-) decrease the torque, turn Knob Y while holding A

For x-axis to (+) increase or (-) decrease the torque, turn Knob X while holding B

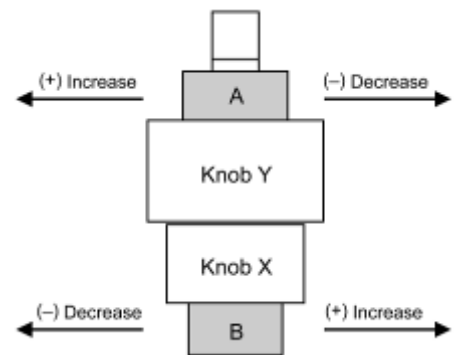

## 3.4 Specimen holder

- Attach the specimen holder, using the two mounting holes. If the stage is to be used with right-hand controls, attach the specimen holder to the left-hand holes and similarly, with left-hand controls to the right-hand holes.

## 3.5 Objectives

- Lower the stage completely. Screw the objectives into the revolving nosepiece so that clockwise rotation of the nosepiece brings the next higher magnification objective into position.

### 3.6 Condenser

- Raise the stage by turning the coarse focus knob.
- Completely lower the condenser carrier by turning the condenser focus knob.
- Insert the condenser into the dovetail mount with aperture scale facing to the user. Secure it with the condenser clamp screw.
- Turn the condenser focus knob to raise the condenser as far as it will go. (Fig.1)



Fig.1

### 3.7 Eyepiece tube

- Loosen the eyepiece tube clamp screw. Insert the round dovetail mount on the eyepiece tube into the round dovetail mount on the microscope arm. Tighten the eyepiece tube clamp screw to secure the eyepiece tube in place. (Fig.2)



Fig.2

### 3.8 Eyepieces

- Use the same magnification eyepieces for both the eyes.
- Inserting or removing the eyepieces is facilitated by twisting the eyepieces (Fig.3a) when pushing in or pulling out (Fig.3b).



Fig.3a



Fig.3b

### 3.9 Filters

- Remove the collector cover (Fig.4a) and place the filter in the filter holder located around the field lens (Fig.4b), screw the collector cover (Fig.4a), taking care that dust, dirt and fingerprints do not get on the filter and the field lens.



Fig.4a



Fig.4b

- Filter selection:

<b>Filter</b>	<b>Function</b>
ND2 (T=50%)	For brightness adjustment in photomicrography
Blue filter (colour balance filter)	For routine microscopy and photomicrography
Green interference (546nm)	For phase contrast and contrast adjustment with black and white film
HE (didymium filter)	For colour photomicrography of HE stained specimen with tungsten type film

- A special diffuser system is build into the illumination beam path and guaranties a homogen light distribution.

### **3.10 Power cord**

- Connect the socket of the power cord to the AC inlet on the rear of the base of the microscope. Plug in the other end of the cord to an AC outlet with ground conductor.



## 4. Usage of microscope components

### 4.1 Coarse and fine focusing (Fig.5)

- Focusing is carried out with the coarse and fine focus knobs at the left and right of the microscope stand.
- The direction of vertical movement of the stage corresponds to the turning direction of the focus knobs.
- One rotation of the fine focus knob moves the stage 0.1mm. The graduation on the fine focus knob is 1 micron.



Fig.5

**Never attempt either of the following actions, since doing so will damage the focusing mechanism:**

- Rotate the left and right knob while holding the other.
- Turning the coarse and fine focus knobs further than their limit.

### 4.2 Coarse focus torque adjustment (Fig.6)

To increase the torque, turn the torque adjustment ring located behind the left-hand coarse focus knob in the direction indicated by the arrow. To reduce the torque, turn the ring in the direction opposite to that indicated by the arrow.



Fig.6

#### 4.3 Coarse Focus Quick Stop (Fig.7)

- The coarse focus quick stop serves as a quick accessible possibility for the user to limit the upper focus position in order to prevent a collision of the Objective with the specimen.
  - Focus on the specimen using the lowest power objective and the coarse focus knob. Rotate the highest power objective into place. Carefully turn the coarse focus knob raising the specimen until it is just out of focus, but the slide cover slip does not touch the highest power objective.
- Simply turn the lever in clockwise direction as shown in the picture below and lock the actual position as upper limit.
- To loosen the upper limit, just turn the lever in the opposite direction



Fig.7

#### 4.4 Stage Upper Limit Stop adjustment: (Fig.8)

(Upper Stage Limit is preset at the factory; please only adjust if necessary)

- The Stage Upper Limit stop marks the stage position at which the specimen is in focus i.e. by restricting the movement of the coarse focus knob.
- With the specimen in focus, turn the stage upper limit stop knurled ring clockwise until it reaches the stop.
- When the stage upper limit stop is in position, the Stage cannot be raised from that position. However, the fine focus knob can move the stage regardless of the limit but will only lower the stage.
- Lower the stage by using the coarse focus knob anticlockwise



Fig.8

#### 4.5 Using Thicker Samples

- Loose the screw (Fig.9a)
- Lower down the stage (Fig.9b)
- If the travel range is not enough for using, please remove the collector cover.



Fig.9a

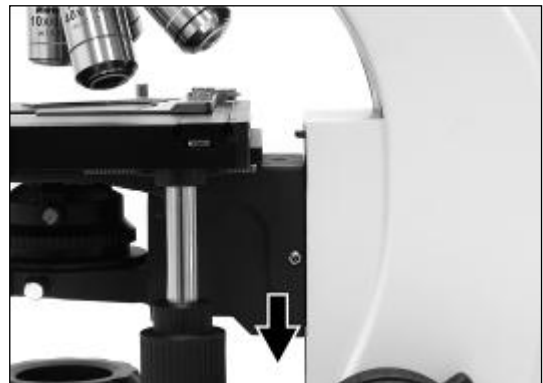

Fig.9b

#### 4.6 Beam Splitter Lever (Fig.10)

- When the beam splitter lever is pushed in, 100% of the light will enter the eyepieces.  
When pulled out, the light beam will be divided as follows:
- 80:20 (visual: photo; standard tube) 0:100 (visual: photo; tube for low light situations, optional tube)
- The triple position tube (optional) is the most flexible tube by giving 2 photo positions:
- 80:20 (visual: photo; for simultaneous observation by eyepiece and camera)
- 0:100 (visual: photo; for low light situations, e.g. fluorescence)



Fig.10

#### 4.7 Interpupillary distance adjustment (Fig.11)

- Before adjusting the interpupillary distance, bring a specimen into focus using the 10x objective.
- Adjust the interpupillary distance so that both the right and left field of view become one.
- This adjustment will enable the user to observe the specimen with both eyes



Fig.11

- Eyepiece tubes can be swivelled up or down to adjust the viewing height to suit individual preference of comfort viewing. The eye height can be increased by 62mm (Fig.12)



Fig.12

#### 4.8 Diopter adjustment (Fig.13)

- Every human eye is different, to adjust the Instrument to best performance adjustment can be necessary.
- Set the diopter on both eyepieces to the “0” position.
- Change to 10x Magnification and focus the image of the specimen with one eye only.
- Use the Eye which is most convenient for first focussing.

- When the best focus position is reached, close this eye and use the other eye for the following steps.
- Correct the focus for the second eye by using only the Diopter Ring, do not use the coarse / fine focusing knob!
- Change to a higher magnification to verify the result and if necessary repeat the procedure to match the sharpness for higher magnification.
- Keep this final diopter position for all magnification / lenses. The diopter position for each **user** can be recorded from the scale, so it can easily be reset.



Fig.13

#### 4.9 Centering the condenser (Fig.14)

- Fully open the field of view diaphragm and condenser aperture diaphragm.
- Set the specimen on the stage with the cover glass facing up.
- Bring the specimen image into focus, using the 10x objective.
- Turn the condenser focus knob to bring the field diaphragm image into focus on the specimen plane.
- Adjust the condenser by using the condenser centering screws.
- Adjust the field diaphragm so that it is just outside the field of view for each magnification change.

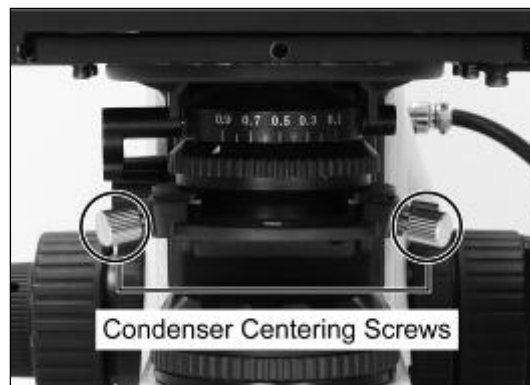

Fig.14

#### 4.10 Use of aperture diaphragm

- The condenser aperture diaphragm is provided for adjusting the numerical aperture (N.A.) of the illuminating system of the microscope, it decides the resolution of the image, contrast, depth of focus and brightness.
- Stopping down will lower the resolution and brightness but increase the contrast and depth of focus.
- An image with appropriate contrast in most cases can be obtained with an aperture diaphragm closed down to 2/3 of the maximum value.
- To adjust the aperture diaphragm:
  - adjust the condenser aperture diaphragm ring referring to the condenser aperture scale, or
  - by observing the diaphragm image visible on the exit pupil inside the eyepiece tube, or
  - by using a centering telescope after removing one of the eyepieces and focusing on the aperture diaphragm.
- When swinging-out the top lens of the condenser for low magnification objectives, open the condenser aperture diaphragm completely.

#### 4.11 Use of field diaphragm (Fig.15)

- The field diaphragm determines the illuminated area on the specimen. For normal observation, the diaphragm is set slightly larger than the field of view. If the illuminated area is set much larger than the field of view extraneous light will enter the field of view. This will create a flare in the image and lower the contrast.
- In case the image of the field diaphragm cannot be centered due to thick glass slides or chambers with thick bottoms, a long working distance condenser is available for correct Koehler illumination.
- The diaphragm does not have any effect when the condenser top lens is swung out of the optical path. Fully open the field diaphragm, as the N.A. of the illuminating system will be reduced if the diaphragm is excessively stopped down.



Fig.15

#### 4.12 Brightness and contrast adjustment

- Neutral density filters are used for brightness adjustment in routine microscopy and photomicrography.
- For phase contrast and contrast adjustment with black and white film, a Green interference filter (546nm) is recommended.
- An HE (didymium) filter for colour photomicrography, Haematoxylin, Eosin (HE) or Fuchsin stained specimen with tungsten type film is available.

#### 4.13. IR function

- Push the button (Fig.16), the blue pilot lamp indicates that an IR-sensor is activated. If nouser is detected in front of the microscope, the microscope illumination will automatically switch off after 15 minutes. When the user returns, the illumination will start again.



Fig.16

#### 4.14 Auto light intensity reproduction (Fig.17)

- Rotate the desired Objective into the light path by turning the nosepiece on its knurled collar and adjust Intensity according to the actual slide sample. After 10 seconds of constant illumination, the system will store this brightness value as setting and it will repeat this illumination setting once the same Nosepiece position with Objective will be rotated into the light beam again.
- Manual changes to this setting are possible every moment of time, once the new illumination brightness will be constant for 10s again, it will override the last setting
- Repeat procedure according to above procedure for all installed nosepiece positions

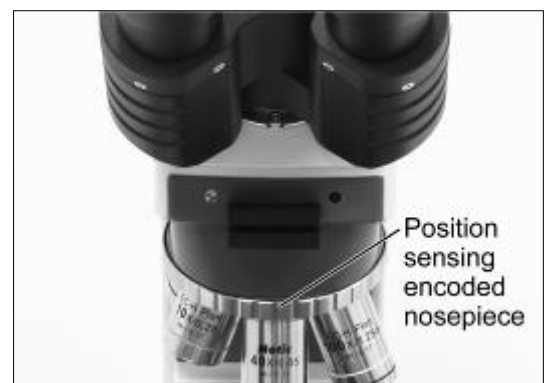

Fig.17

#### 4.15 Filters cassette

- Loose out the base plate screws and open the base plate (Fig.18a and Fig.18b)
- Move out the filter cassette cover (Fig.18c)
- Insert the filter cassette in the stand (Fig.18d and Fig.18e)
- Insert the filter slider in the filter cassette (Fig.18f)

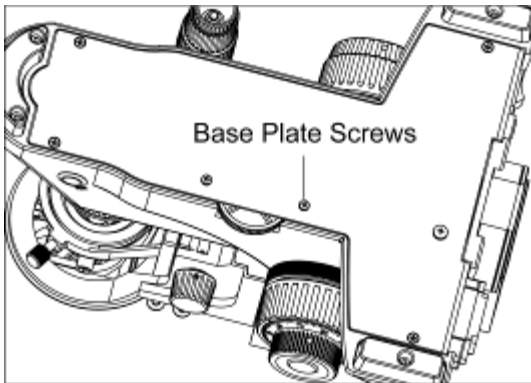

Fig.18a

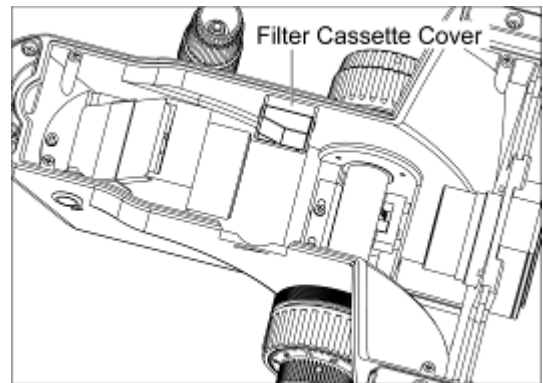

Fig.18b

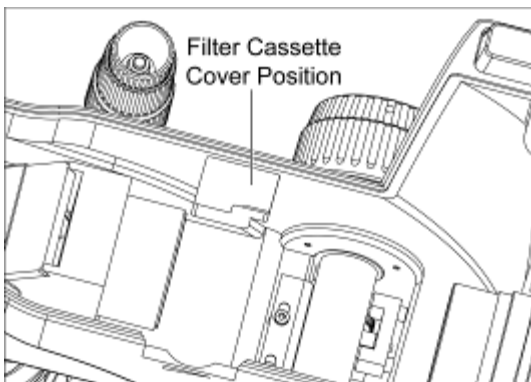

Fig.18c

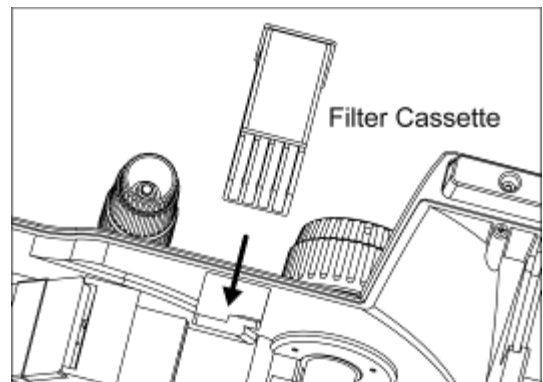

Fig.18d

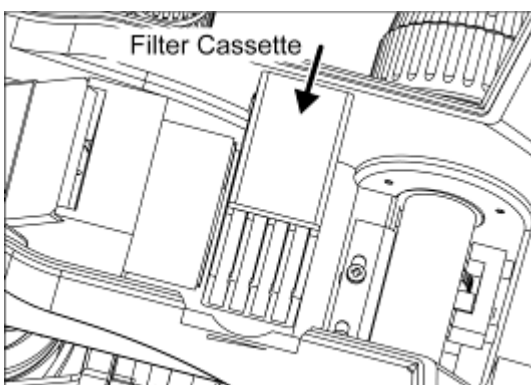

Fig.18e

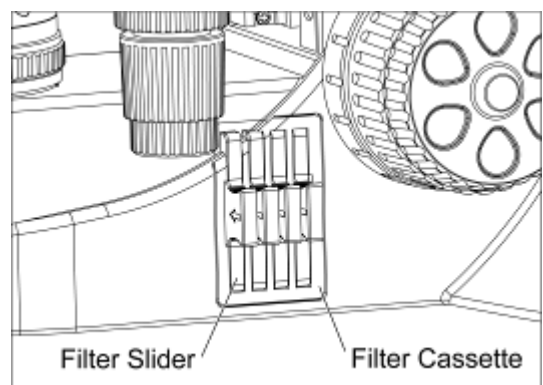

Fig.18f



## 5. Photomicrographic procedure

- To ensure vibration free operation, set the microscope on a sturdy vibration free table or a bench with a vibration proof device.
- Pull the optical path selection lever of the trinocular eyepiece tube all of the way out to the limit.
- To ensure optimal illumination, check the position and centring of the lamp and position of the condenser.
- Select a blue filter for routine application. An additional colour-compensating filter can also be used depending on the colour rendition.
- Adjusting the field diaphragm is important for the purpose of limiting extraneous light that may cause flare and lower the contrast. Stop down the diaphragm to achieve an illuminated area slightly larger than that of the field of view.
- A change in depth of focus, contrast and resolution of the image is attainable with an aperture setting of  $2/3$  of the maximum diaphragm diameter.  
Fine setting of the condenser aperture varies with the individual sample.
- For specific photomicrographic procedures, refer to the manual of the specific camera being used.

## 6. Using oil immersion objective

- Oil immersion objectives are labelled with the additional engraving "Oil" and are to be immersed in oil between the specimen and the front of the objective.
- The immersion oil supplied by Motic is synthetic, non-fluorescing and non-resining oil, with a refractive index of 1.515
- Normally, cover glass must be used with oil immersion objectives with a few exceptions.

### Deviations

from thickness are not important as a layer of immersion oil acts as compensation above the cover glass.

- The small bottle of oil supplied with every immersion objective facilitates application of the oil to the cover slip.
- Remove any air bubbles in the nozzle of the oil container before use.
- Immersion oil must be used sparingly. After the examination, the oil should be wiped off the objective with a lens cleaning tissue and the residual film removed with soft cloth moistened with petroleum benzene or absolute alcohol.
- Locate the field of interest with a lower magnification objective. Swing the objective out of the light path, and add one drop of immersion oil over the site of the specimen. Swing in the oil immersion objective. There should be a small column of oil from the cover slip to the objective lens. Use the fine focus to make the image sharp.
- Freedom from air bubbles must be ensured. To check for air bubbles, remove an eyepiece, fully open the field and aperture diaphragms, and look at the exit pupil of the objective within the eyepiece tube. Air bubbles are recognized by a surrounding black ring. Bubbles may often be dislodged by moving the slide to and fro or by slightly rocking the revolving nosepiece back and forth. If not successful in clearing the bubbles then the oil must be wiped off and replaced with a fresh drop.

## 7. Troubleshooting table

As you use your microscope, you may occasionally experience a problem.

The troubleshooting table below contains the majority of frequently encountered problems and the possible causes.

### Optical

Problem	Possible Cause
Vignetting or uneven brightness in the field of view	Bulb not installed properly
	Condenser not mounted correctly
	Condenser is not centred
	Condenser is set too low
	Condenser top lens not fully swung in/out
	Field diaphragm closed too far
	Aperture diaphragm closed too far
	Improper condenser/objective combination
	Revolving nosepiece not clicked into position
	Trinocular eyepiece tube optical path selector lever in intermediate position
Dust or dirt in the field of view	Aperture diaphragm closed too far
	Condenser is set too low
	Dust or dirt on specimen surface
	Dust or dirt on field lens, filter, condenser or eyepiece
Poor image (low contrast or resolution)	Condenser is set too low
	Aperture diaphragm closed too far
	No cover glass
	Too thick or thin cover glass
	Immersion oil not used with oil immersion lens
	Air bubbles in immersion oil
	Specified immersion oil not used
	Immersion oil on dry objective
	Greasy residue on eyelens
Incorrect illumination	

Poor image (low contrast or resolution)	Dried stain or oil on objective lens. Lens must be removed from the microscope and examined with a magnifier (an inverted eyepiece can be used) to check for dirt
Uneven focus	Stage installed on inclined plane
	Specimen holder not fixed securely on stage
	Specimen not secured in position
	Magnification or field of view of left and right eyepieces differ
	Diopter adjustment not made

### Electrical

Bulb does not light	Power supply not plugged in
	Bulb not installed
	Bulb burnt out
Inadequate brightness	Specified bulb not being used
Bulb blows out	Specified bulb not being used
Bulb flickers	Connectors are not securely connected
	Bulb near end of service life

## 8. Care and maintenance

### 8.1. Do not disassemble

- a. Disassembly may significantly effect the performance of the instrument, and may result in electric shock or injury and will void the terms of the warranty.
- b. Never attempt to dismantle any parts other than described in this manual. If you notice any malfunction, contact your nearest Motic representative.

### 8.2 Cleaning the Microscope

- a. Lenses and filters
  - To clean lens surfaces or filters, first remove dust using an air blower. If dust still persists, use a soft / clean brush or gauze.
  - A soft gauze or lens tissue lightly moistened with the mixture of alcohol and ether ( ratio: alcohol: 3 and ether: 7) should be used to remove grease or fingerprints.
  - Use only a mixture of alcohol and ether ( ratio: alcohol: 3 and ether: 7) to remove immersion oil from objective lenses.
  - Because the mixture of alcohol and ether ( ratio: alcohol: 3 and ether: 7) is highly flammable, be careful handling around open flame.
  - Do not use same area of gauze or lens tissue to wipe more than once.
- b. Cleaning of painted or plastic components
  - Do not use organic solvents (thinners, alcohol, ether, etc.). Doing so could result in discolouration or in the peeling of paint.
  - For stubborn dirt, moisten a piece of gauze with diluted detergent and wipe clean.
  - For plastic components, only moisten a piece of gauze with water and wipe clean.

### 8.3 Disinfecting the Microscope

- Follow the standard procedures for your laboratory.

### 8.4 When not in use

- When not in use, cover the instrument with vinyl dust cover and store in a place low in humidity where mould is not likely to form.
- Store the objectives, eyepieces and filters in a container or desiccator with drying agent.
- Proper handling of the microscope will ensure years of trouble free service.
- If repair becomes necessary, please contact your Motic agency or our Technical Service direct.

#### Note:

- If equipment is used in a manner not specified by the manufacturer, the warranty may be void.
- To avoid getting wet, do not use the microscope near water.

## 8.5 Bulb Replacement



The bulb and the lamphouse become very hot during and after a period of operation. Risk of burn – Do not touch the bulb during or immediately after a period of operation. Make sure the bulb has cooled sufficiently before attempting to replace the lamp.



In order to prevent electric shock always turn the power switch off and unplug the power cord before installing or replacing the lamp.

### 8.5.1 50W Halogen

- The applicable halogen bulbs are the 12V 50W HAL high-intensity bulb. (Osram, model: 64610 HLX)
- Loosen the lamp housing cover clamp screw using a coin and remove the cover. (Fig.19a)
- When installing the bulb, do not touch the glass surface of the bulb with bare fingers.

Doing so will cause fingerprints, grease, etc., to burn onto the bulb surface, reducing the illumination provided by the bulb. If the surface is contaminated, wipe it clean using lens tissue.

- Firmly insert the bulb into the socket pinholes until it reaches the limit. Be careful not to tilt the bulb when mounting. (Fig.19b & 19c)
- Close the cover and secure with it with lamp housing cover clamp screw.



Fig.19a

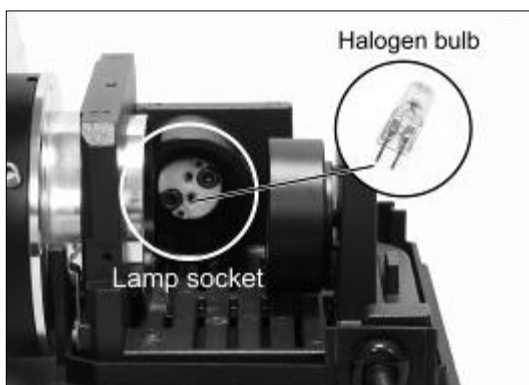

Fig.19b



Fig.19c

### 8.5.2 3W LED module

- This is a Motic **patented** design to exchange LED module and halogen bulb on the same socket directly. (Fig.20b). 3W LED module is used for 50W lamp house only.
- Loosen the lamp housing cover clamp screw using a coin and remove the cover. (Fig.20a)
- When installing the LED module, do not touch the glass surface of the bulb with bare fingers. Doing so will cause fingerprints, grease, etc., to burn onto the bulb surface, reducing the illumination provided by the bulb. If the surface is contaminated, wipe it clean using lens tissue.
- Firmly insert the LED module into the socket pinholes until it reaches the limit (Fig.20b), be careful not to tilt the LED module when mounting. (Fig.20c)
- Close the cover and secure with it with lamp housing cover clamp screw. (Fig.20d)



Fig.20a

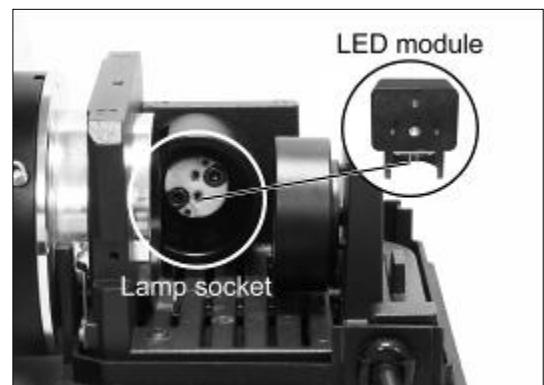

Fig.20b

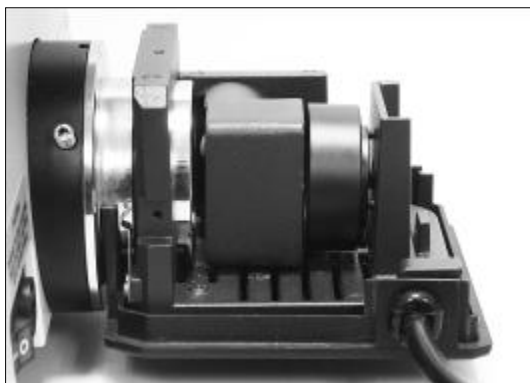

Fig.20c



Fig.20d

### 8.5.3 100W Halogen

- The applicable halogen bulbs are the 12V 100W HAL high-intensity bulb.  
(Osram, model: 64625 HLX)
- Loosen the lamp housing cover clamp screw (Fig.21a) and remove the cover (Fig.21b).
- When installing the bulb, do not touch the glass surface of the bulb with bare fingers. (Fig.21c)  
Doing so will cause fingerprints, grease, etc., to burn onto the bulb surface, reducing the illumination provided by the bulb. If the surface is contaminated, wipe it clean using lens tissue.
- Firmly insert the bulb into the socket pinholes until it reaches the limit. Be careful not to tilt the bulb when mounting.
- Close the cover and secure with it with lamp housing cover clamp screw. (Fig.21d)

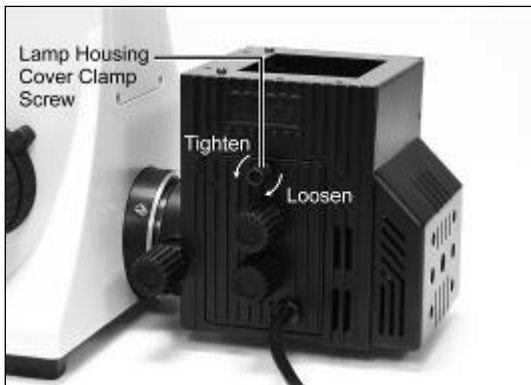

Fig.21a



Fig.21b

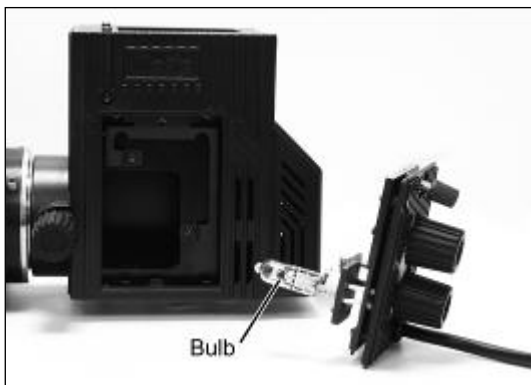

Fig.21c









Fig.21d



## 9. Warning labels

The following warning labels (or symbols) are found on the microscope, study the meaning of the warning labels (or symbols) and always use the equipment in the safest possible manner.

Warning Label / Symbol	Explanation
	Indicates that the surface becomes hot, and should not be touched with bare hands.
	Indicates that the main switch is ON.
	Indicates that the main switch is OFF.
	Indicates alternating current.
	Indicates direct current.
	WARNING: Always replace the protective conductor after servicing.

The bulb and the lamphouse become very hot during and after a period of operation.  
 Risk of burn – Do not touch the bulb during or immediately after a period of operation.  
 Make sure the bulb has cooled sufficiently before attempting to replace the bulb.

Don't pick the microscope up from the bottom during equipment operation.

Proper handling of the microscope will ensure years of trouble free service.

If repair become necessary, please contact your Motic agency or our Technical Service directly.

**Motic®**



September 2014

**Motic Hong Kong (Hong Kong)**

Unit 2002, L20, Tower Two, Enterprise Square Five, 35 Wang Chiu Road, Kowloon Bay, Kowloon  
Tel: 852-2837 0888 | Fax: 852-2882 2792

**Motic Instruments (Canada)**

130-4611 Viking Way, Richmond, BC V6V 2K9 Canada  
Tel: 1-877-977 4717 | Fax: 1-604-303 9043

**Motic Deutschland (Germany)**

Christian-Kremp-Strasse 11, D-35578 Wetzlar, Germany  
Tel: 49-6441-210 010 | Fax: 49-6441-210 0122

**Motic Europe (Spain)**

C. Les Corts 12, Pol. Ind. Les Corts, 08349 Cabrera de Mar, Barcelona, Spain  
Tel: 34-93-756 6286 | Fax: 34-93-756 6287

**Motic China Group (China)**

Motic Building, Torch Hi-Tech Industrial, Development Zone, Xiamen P.R.C.  
Tel: 86-0592-562 7866 | Fax: 86-0592-562 7855

© 2007-2013 Motic China Group Co. Ltd. All rights reserved. Motic is a registered trademark and service mark of Motic China Group Co., Ltd. Microsoft Windows logo is a registered trademark of Microsoft Corporation. All other trademarks are the property of their respective owners.

Motic Incorporation Limited Copyright © 2002-2017 All rights reserved.

Design Change: The manufacturer reserves the right to make changes in instrument design in accordance with scientific and mechanical progress, without notice and without obligation.